

VDO - Instrument Installation Guide

The following schematics are generalized instructions re-printed from VDO. Some gauges may require additional adapters, senders, or even hardware not normally sold with gauge to properly complete installation.

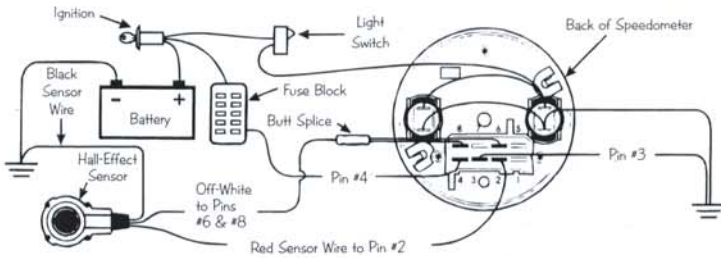

Proper wiring of Speedometer using: Hall-Effect Sensors

Wiring with Electronic Ignition

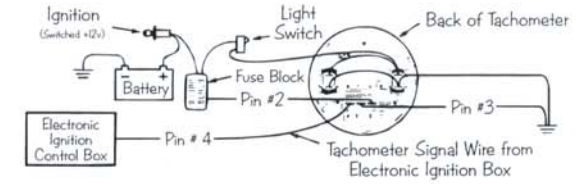

Wiring with Coil

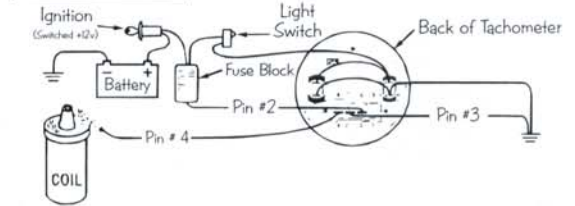

Proper wiring of Speedometer using: Hall-Effect Sensors

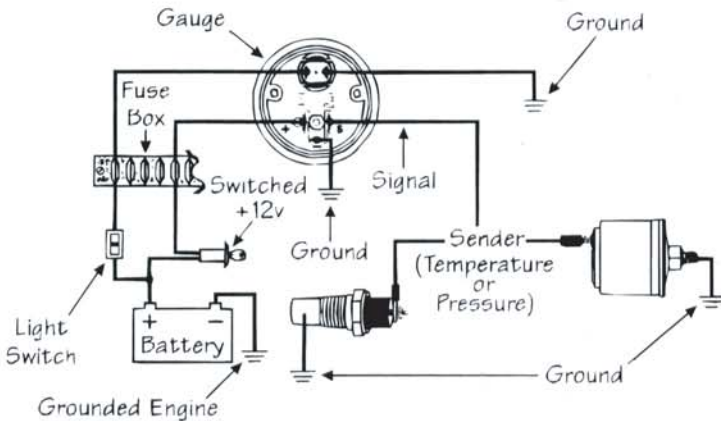

Proper wiring of the Oil Temperature or Pressure Gauge

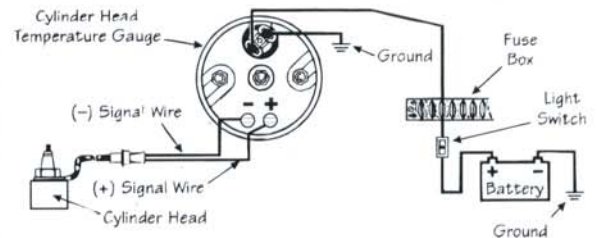

Proper wiring of the Cylinder Head Temperature Gauge

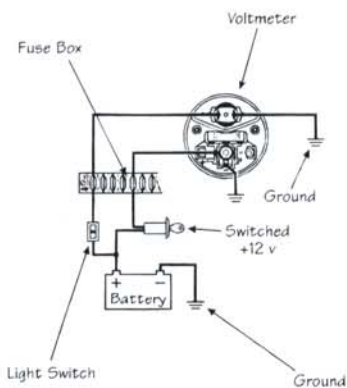

Proper wiring of Voltmeter

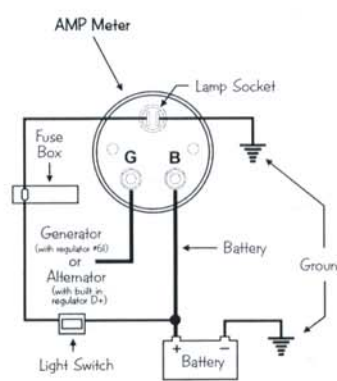

Proper wiring of AMP Meter

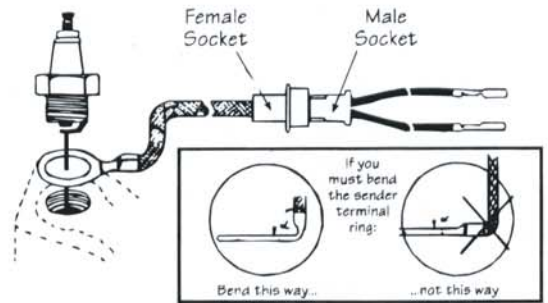

Proper installation of the Cylinder Head Temperature Sender

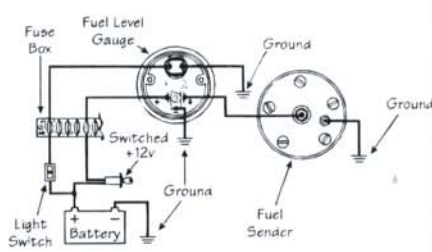

Proper wiring of Fuel Gauge

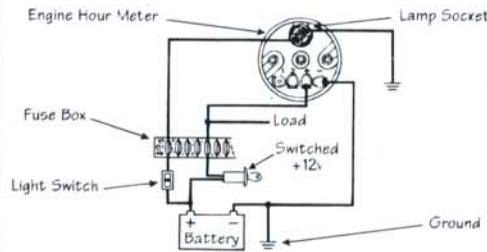

Proper wiring of Engine Hourmeter

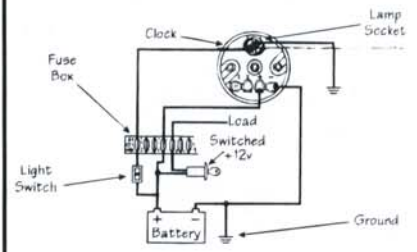

Proper wiring of Quartz Clock